



**Motic**<sup>®</sup>

MORE THAN MICROSCOPY

# SMZ161

**BASIC  
STEREO  
MICROSCOPE**

# SMZ161

**M**otic's new **SMZ161 Stereo Zoom microscope** joins the widespread success of the SMZ Stereo family by introducing **light materials** as well as a new, improved LED illumination options. Convincing optical performance, combined with a small footprint and robust mechanics, makes the SMZ161 the ideal stereo microscope for teaching situations in High Schools and Universities.

The **Greenough optical system** delivers clear and distortion-free images with an **improved zoom range of 6:1**. **Parfocality** is ensured while running **through the complete magnification range; while a click-stop mechanism**, implemented in the continuous zoom, enables **precise reproduction of magnifications**. The extended **110mm working distance** in its standard configuration gives sufficient space for sample manipulation, using its convincing 3-dimensional upright image.



**BASIC  
STEREO  
MICROSCOPE**





## Eyepieces

The SMZ-161's **standard Widefield WF10X/20mm** eyepieces follow the **high eyepoint** principle, which allows spectacle wearers access to the complete field of view. A diopter adjustment of  $\pm 5$  dpt is possible on both eyepiece tubes, while standard rubber eye guards minimize stray light and increase viewing comfort. The **interpupillary distance** can be adjusted between **50-75mm**. Besides the standard WF10X/20 eyepieces, the SMZ-161 Series also offers **alternative eyepieces**: N-WF 10X (F.N.23), N-WF 15X (F.N.16) and N-WF 20X (F.N.13).

For measuring purposes, a series of reticules are available:

Bidirectional scale 10mm:100 and crosshair

Bidirectional scale 10mm:100

Micrometer (100 divisions in 10mm) (25mm diameter) with crosshair

Micrometer (100 divisions in 10mm) (25mm diameter)

Scale 360°: 360 and crosshair

Scale 360°: 36 and crosshair

Simple crosshair

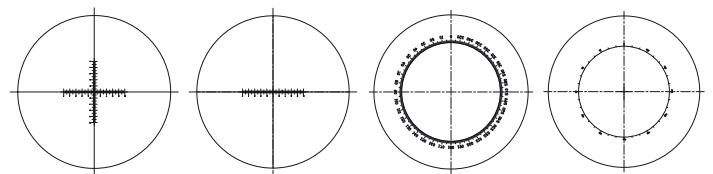

## Zoom Range

With the SMZ-161, it is now both an easy and effortless task to step from a sample overview down to minute details. **One precise rotation of the zoom knob** gives access to the **complete magnification range**. Defined **click-stop positions within the continuous zoom range** allow exact magnification reproductions, a necessary precondition for **reproducible calibrations** and **precise measurements** when reticules or digital tools are used.

The **6:1 zoom** ratio delivers a **standard** magnification range of **7.5X-45X**. Due to the **parfocal optical design**, a re-adjustment of the focus position is not necessary while zooming.

To increase the model's **magnification range** a complete selection of **auxiliary objectives and eyepieces** are available - extending the SMZ-161's total magnification range from 2.25X up to 180X.

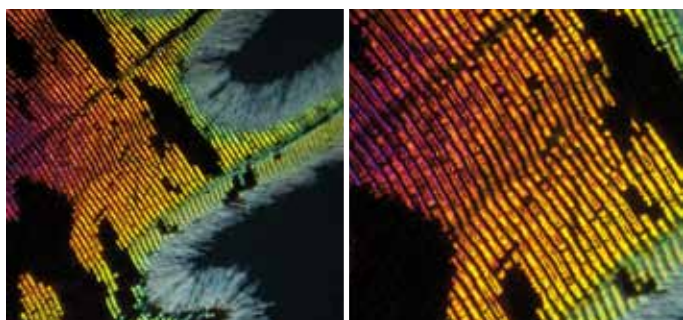

## Auxiliary Objectives

The **standard** SMZ-161 configuration comes with a **110mm working distance**, offering ample space for sample manipulation. The maximum field diameter (with lowest zoom position and standard **10X/20** eyepieces) is 26.7mm. Higher magnifications can be achieved by using the following **auxiliary objectives**, (following even ESD requirements):

Magnification	W.D.(mm)	Max. Field Diameter (with 10X/20 eyepiece)
1.5X	56.3	17.8
2X	38.6	13.3

A larger sample overview is possible by choosing the following auxiliary objectives:

Magnification	W.D.(mm)	Max. Field Diameter (with 10X/20 eyepiece)
0.3X	301	88.9
0.5X	191.8	53.3
0.63X	142.7	42.3
0.75X	128.6	35.6



## 3-D Image

Stereo microscopes have found numerous **applications in biology, medicine and industrial quality control**. The nature of the upright image of a stereo microscope is essential when manipulation work on living and “dead samples” occurs. Without the need for an often time consuming sample preparation, stereo microscopes are also ideal instruments for a first step into the “micro world” in education environments. Thanks to its **compact dimensions** and **robust mechanics**, Motic's SMZ-161 is ideal for any kind of teaching application. Based on the **Greenough Optical System** with its completely separated viewing paths (a proven concept time-tested for more than 100 years), the SMZ-161 delivers **distortion-free 3-D images**. Also further enhancing its image quality, **multi-layered lens coatings** deliver high contrast images with reduced internal reflections.



### The Working Distance

Sample manipulation is one of the main activities when using a stereo microscope. The upright image orientation is especially helpful essential when using tweezers, needles or similar dissection instruments.

With its standard configuration, the SMZ-161 provides a large **working distance of 110 mm**, which can be easily **extended to 301mm** (with additional auxiliary objective 0.3X). To achieve a desired total magnification, objective magnifications less than 1X may be compensated by using higher eyepiece magnifications (up to 20X).



## Standard Packages

Motic's SMZ-161 optical heads come as **Binocular** or **Trinocular** versions, each with a **45° viewing angle**, WF10X/20 eyepieces and built-in 1X objective lens. The interlocking eyepieces can be adjusted within an interpupillary distance of 50-75mm. For special experimental setups or OEM inspection applications, a compact **Binocular head with 60° viewing angle** is also available. The **anti-fungus treatment** of all optics allows the use of the SMZ-161 in a variety of humid environments. The dovetail focusing mechanism of the SMZ-161 ensures **smooth focusing** and **stable focus positions**, while a "slip function" helps to prevent excessive gear extrusion when coming to the upper or lower limit positions.

Besides the variability in optical setup (auxiliary objectives/eyepieces), a set of 6 basic packages can be chosen. Beside the compact BP/TP stands for optional Incident light only, the SMZ-161 R2GG stand type offers built-in Halogen light sources: 12V/20W for Transmitted light, 12V/10W for Incident light. The respective SMZ-161 R2LED version comes with 3W LEDs. This type is especially recommended for temperature-sensitive living samples. Both Incident and Transmitted light can be activated simultaneously and adjusted separately. These new and improved stands all come with a built-in reflector for a more intense or angled illumination for critical samples. Pure Transmitted light stands are also available.



Built-in reflector for better illumination

### The standard packages



SMZ-161-BP

SMZ-161-TP

SMZ-161-BL

SMZ-161-TL

SMZ-161-BLED

SMZ-161-TLED

Description	SMZ-161-BP	SMZ-161-TP	SMZ-161-BL	SMZ-161-TL	SMZ-161-BLED	SMZ-161-TLED
SMZ-161 Binocular 45°	●		●		●	
SMZ-161 Binocular 60°	●		●		●	
SMZ-161 Trinocular 45°		●		●		●
Fixed Widefield 10X/20 eyepieces	●	●	●	●	●	●
Plain stand - plain base	●	●				
Plain stand - holder	●	●				
Pole stand with illuminator (HAL)			●	●		
Pole stand with illuminator (LED)					●	●

● included ● available as optional

## Modular Configuration

Besides the Standard packages, the SMZ-161 system also offers modular components for a personal configuration depending on the requirements of the workplace set-up. **The industrial boom stands** for larger viewing samples may replace the Plain and Transmitted light stands to increase user freedom significantly. A new slot/groove design improves the stability of the desired optics position without slant. And for easier transport, all new round/rectangle bases maintain an “easy hand-carrying shape”. All these stands require a separate illumination system following the requirements of the sample.

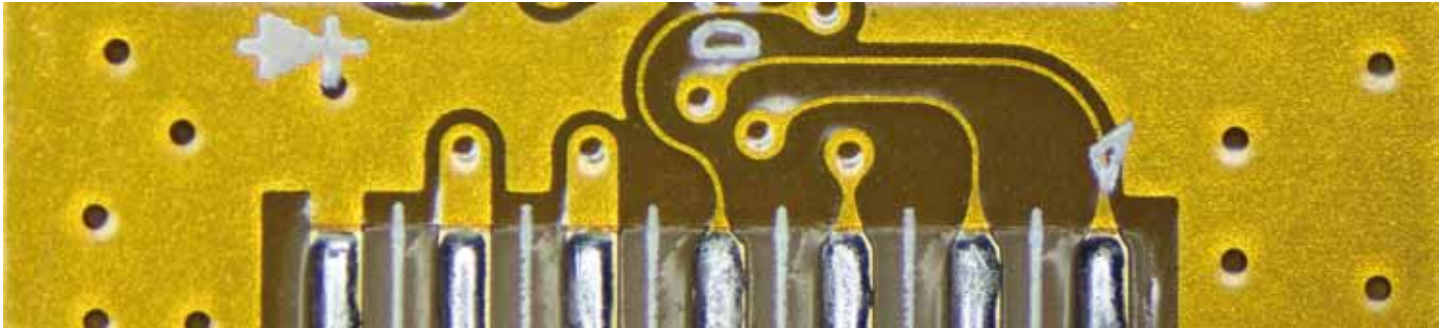

1. Special Universal stand (round base)

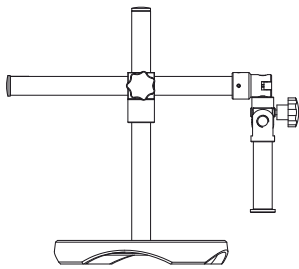

Base: Ø300mm, 40mm thick  
 Vertical pole: Ø32mm  
 Height of vertical pole: 400mm (optional: 600mm)  
 Focusing pole: Ø25mm  
 Max. distance from pole to optical centre: 537mm

2. Special Universal stand (squared base)

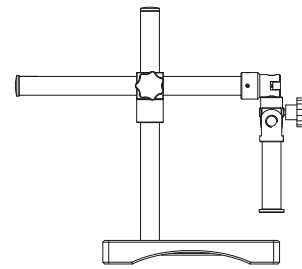

Base: 300x300x40 mm  
 Vertical pole: Ø32mm  
 Height of vertical pole: 400mm (optional: 600mm)  
 Focusing pole: Ø25mm  
 Max. distance from pole to optical centre: 537mm

3. Industrial arm boom stand

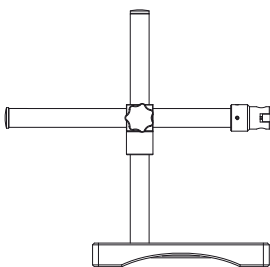

Base: 300x300x40 mm  
 Vertical pole: Ø32mm  
 Height of vertical pole: 400mm (optional: 600mm)  
 Industrial arm: Ø16mm  
 Max. distance from pole to optical centre: 537mm  
 Connected with the industrial arm directly without focusing connector

4. Articulating boom stand (clamp version)

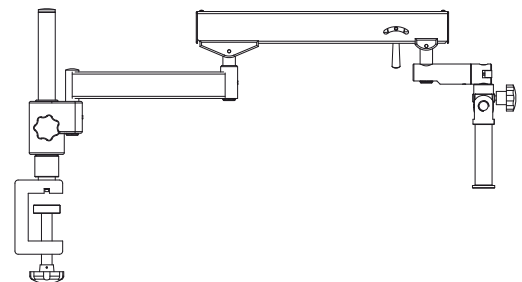

Vertical pole: Ø32mm  
 Height of vertical pole: 400mm (optional: 600mm)  
 Focusing pole: Ø25mm  
 Maximum thickness of table: 75mm  
 Max. distance from pole to optical centre: 955mm





**5. Articulating boom stand**

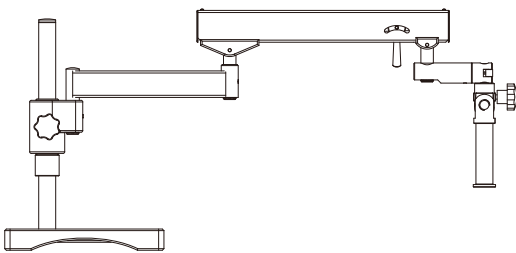

Base: 300x300x40 mm  
 Vertical pole: Ø32mm  
 Height of vertical pole: 400mm (optional: 600mm)  
 Focusing pole: Ø25mm  
 Max. distance from pole to optical centre: 955mm

**6. Ball bearing boom stand (clamp version)**

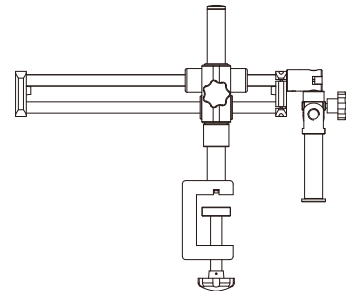

Vertical pole: Ø32mm  
 Height of vertical pole: 400mm (optional: 600mm)  
 Focusing pole: Ø25mm  
 Maximum thickness table: 75mm  
 Max. distance from pole to optical centre: 575mm

**7. Ball bearing boom stand**

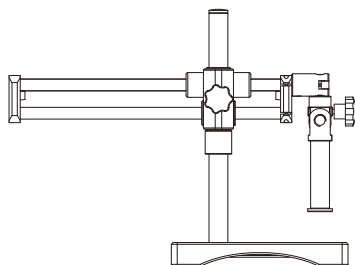

Base: 300x300x40 mm  
 Vertical pole: Ø32mm  
 Height of vertical pole: 400mm (optional: 600mm)  
 Focusing pole: Ø25mm  
 Max. distance from pole to optical centre: 575mm

**8. Manual movement stand**

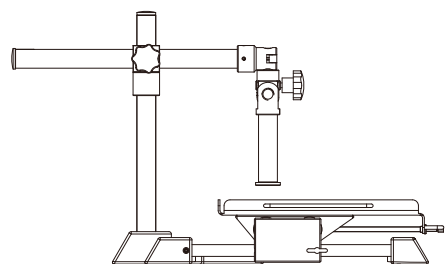

Surface perimeter: 450mm x 350mm  
 X movement: 410mm  
 Y movement: 220mm  
 Vertical pole: Ø32mm  
 Height of vertical pole: 400mm (optional: 600mm)  
 Focusing pole: Ø25mm

## Illumination

Illumination is a critical issue to ensure the proper image rendering when using a stereo microscope. To reveal all possible information from the sample, a careful thought on illumination needs to be executed. Motic offers a wide range of illumination options to be combined with the SMZ-161 optics. The **built-in illumination of the base stands** provide the **most compact** and easy illumination option. Especially for **living samples** in biology, Motic recommends LED illumination due to its negligible heat development and minimized impact on living specimens.

However, for more demanding applications, a more powerful or variable solution may be necessary. A **ring light** might be required for a **shadow-free image**, while the visualization of a surface structure may need a unidirectional illuminator by combining a cold light source with a light guide.

Optional ring lights are:

**2401K Fluorescent ring illumination 220V/12W 6400K color temperature (CE)**

**LED ring illumination 60T-B dimmable +/- 6800K color temperature (CE)**

**LED ring illumination 60T dimmable and segmentable +/- 6500K color temperature (CE)**

---

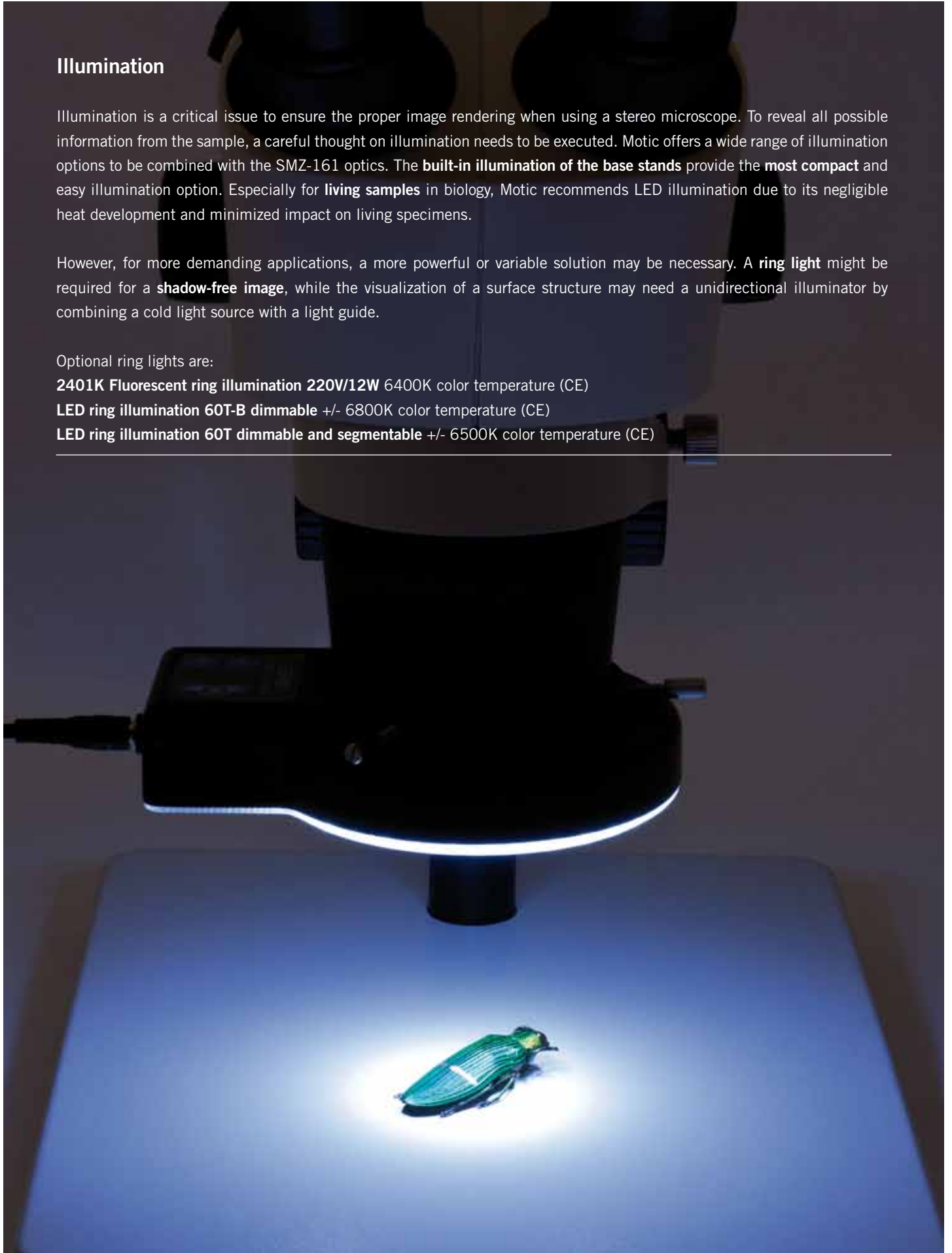



A more powerful solution is provided by the Motic Cold light source MLC-150. A variety of light guides for flexible illumination options are also available.

**Flexible PVC sheathing light guide**

1.5m length with standard straight distal end type

**Ring light guide Ø 61mm**

1m length with Ø 61mm distal end

**Gooseneck 1-Arm light guide**

0.5m length with standard straight distal end type

**Gooseneck 2-Arm light guide**

0.5m length with standard straight distal end type





## Accessories

Especially when working with higher magnifications, **handling samples** becomes more sensitive to vibrations. For this, an appropriate solution to increase viewing comfort may be found within the SMZ-161's optional stage accessories.

### Gliding stage

For smooth multidirectional movement of the sample, a **360° rotatable gliding stage** can be **mounted onto the base plate** of a Plain or Transmitted light stand.

### x/y-stage

An attachable x/y-stage with **76X54mm travel range** enables a precise bidirectional movement.

### Polarizer, Analyzer

To analyze the **birefringence of transparent materials**, a polarizing set-up is required. The respective **polarizer/analyzer combination** for the SMZ-161 is fixed on top of the light exit of the transmitted light stand.

### Darkfield insert

For **Darkfield applications**, a special **DF insert** is mounted **on top of the light exit** of the Transmitted light stand. The iris diaphragm allows variation of the **illumination aperture** according to the numerical aperture of the objective in use.

## Standard Photomicrography

The adaption of a traditional single lens reflex camera (SLR), today mostly digital, requires a Trinocular version of the SMZ-161. The camera **adapter** consists of a **mechanical part, to be combined with a 2.5X or 4X photo eyepiece**. The necessary **T2 adapter** which connects to the camera's bayonet mount-type is supplied by the respective camera manufacturer. This setup delivers **high resolution images of small fields**.

## Digital Documentation

A more convenient setup is provided through **Motic's philosophy of easy image digitalization**. The combination of a SMZ-161 with a member of the Moticom Series of digital cameras delivers **excellent live images**, which can easily be stored for future usage. **All Motic cameras come equipped with software** to transform the SMZ-161 into an analysis and documentation workstation. For the Binocular SMZ-161, multiple eyepiece adapters for Motic cameras are available. The Trinocular SMZ-161 allows the use of **different camera adapters**, depending on the **chip size** of the camera in use. Motic offers a **complete range of digital cameras**, starting with a basic resolution of 1MP (CMOS) up to the research grade Moticom Pro Line (CCD) with a range of 1 megapixel and beyond, including Monochrome and Cooled versions where necessary. These Moticom cameras deliver sharp live images with an all-inclusive software package for easy post-capture handling, measurement and annotation. For further details on our range of cameras, as well as on adaptation questions, please contact your nearest Motic office or your local authorized Motic Professional reseller.



## SMZ-161 General Specifications

Model	SMZ-161-B	SMZ-161-T
Optical system	Greenough	
Observation angle	45°/60°	45°
Magnification range (standard)	0.75X - 4.5X	
Zoom ratio	1:6	
Eyepiece	N-WF 10X (Ø20) / Eyepiece tube adjustable - Optional: N-WF 10X (Ø23), RoHS lens: 15X (Ø16), 20X (Ø13)	
Interpupillary adjustment	50mm-75mm	
Height of eye point	367mm	
Working distance	110mm	
Max. working distance	301mm	
Weight	3.7Kg (head 1.2Kg)	
C-Mount adapter	-	0.5X, 0.65X, 1X adapters available
Photo adapter	-	Photo adapter, 2.5X, 4X photo eyepiece available
Auxiliary ESD objectives	0.3X (WD = 301 mm) - 0.5X (WD = 191.8 mm) - 0.63X (WD = 142.7 mm) 0.75X (WD = 128.6 mm) - 1.5X (WD = 56.3 mm) - 2.0X (WD = 38.6 mm)	
Stand option	See system diagram	

## SMZ-161 Optical Data

Eyepiece	Magnification (X)	Standard Objectives		Auxiliary Objectives											
				0.3X		0.5X		0.63X		0.75X		1.5X		2X	
		WD 110mm		WD 301 mm	WD 191.8 mm	WD 142.7 mm	WD 128.6 mm	WD 56.3 mm	WD 38.6 mm						
		Mag.(X)	F.N.(mm)	Mag.(X)	F.N.(mm)	Mag.(X)	F.N.(mm)	Mag.(X)	F.N.(mm)	Mag.(X)	F.N.(mm)	Mag.(X)	F.N.(mm)	Mag.(X)	F.N.(mm)
10X/20 high eyepoint eyepiece	0.75	7.50	26.67	2.25	88.89	3.75	53.33	4.73	42.33	5.63	35.56	11.25	17.78	15.00	13.33
	1	10.00	20.00	3.00	66.67	5.00	40.00	6.30	31.75	7.50	26.67	15.00	13.33	20.00	10.00
	2	20.00	10.00	6.00	33.33	10.00	20.00	12.60	15.87	15.00	13.33	30.00	6.67	40.00	5.00
	3	30.00	6.67	9.00	22.22	15.00	13.33	18.90	10.58	22.50	8.89	45.00	4.44	60.00	3.33
	4	40.00	5.00	12.00	16.67	20.00	10.00	25.20	7.94	30.00	6.67	60.00	3.33	80.00	2.50
	4.5	45.00	4.44	13.50	14.81	22.50	8.89	28.35	7.05	33.75	5.93	67.50	2.96	90.00	2.22
10X/23	0.75	7.50	30.67	2.25	102.22	3.75	61.33	4.72	48.68	5.62	40.89	11.25	20.44	15.00	15.33
	1	10.00	23.00	3.00	76.67	5.00	46.00	6.30	36.51	7.50	30.67	15.00	15.33	20.00	11.50
	2	20.00	11.50	6.00	38.33	10.00	23.00	12.6	18.25	15.00	15.33	30.00	7.67	40.00	5.75
	3	30.00	7.67	9.00	25.56	15.00	15.33	18.90	12.17	22.50	10.22	45.00	5.11	60.00	3.83
	4	40.00	5.75	12.00	19.17	20.00	11.50	25.20	9.13	30.00	7.67	60.00	3.83	80.00	2.88
	4.5	45.00	5.11	13.5	17.04	22.5	10.22	28.35	8.11	33.75	6.81	67.50	3.41	90.00	2.56
15X/16 high eyepoint eyepiece	0.75	11.25	21.33	3.375	71.11	5.62	42.67	7.09	33.86	8.43	28.44	16.87	14.22	22.5	10.67
	1	15.00	16.00	4.50	53.33	7.50	32.00	9.45	25.40	11.25	21.33	22.50	10.67	30.00	8.00
	2	30.00	8.00	9.00	26.67	15.00	16.00	18.9	12.70	22.50	10.67	45.00	5.33	60.00	4.00
	3	45.00	5.33	13.50	17.78	22.50	10.67	28.35	8.47	33.75	7.11	67.50	3.56	90.00	2.67
	4	60.00	4.00	18.00	13.33	30.00	8.00	37.80	6.35	45.00	5.33	90.00	2.67	120.00	2.00
	4.5	67.50	3.56	20.25	11.85	33.75	7.11	42.52	5.64	50.62	4.74	101.25	2.37	135.00	1.78
20X/12 high eyepoint eyepiece	0.75	15.00	16.00	4.50	53.33	7.50	32.00	9.45	25.40	11.25	21.33	22.50	10.67	30.00	8.00
	1	20.00	12.00	6.00	40.00	10.00	24.00	12.60	19.05	15.00	16.00	30.00	8.00	40.00	6.00
	2	40.00	6.00	12.00	20.00	20.00	12.00	25.20	9.52	30.00	8.00	60.00	4.00	80.00	3.00
	3	60.00	4.00	18.00	13.33	30.00	8.00	37.80	6.35	45.00	5.33	90.00	2.67	120.00	2.00
	4	80.00	3.00	24.00	10.00	40.00	6.00	50.40	4.7	60.00	4.00	120.00	2.00	160.00	1.50
	4.5	90.00	2.67	27.00	8.89	45.00	5.33	56.70	4.23	67.50	3.56	135.00	1.78	180.00	1.33
20X/13	0.75	15.00	17.33	4.50	57.78	7.50	34.67	9.45	27.51	11.25	23.11	22.50	11.56	30.00	8.67
	1	20.00	13.00	6.00	43.33	10.00	26.00	12.60	20.63	15.00	17.33	30.00	8.67	40.00	6.50
	2	40.00	6.50	12.00	21.67	20.00	13.00	25.20	10.32	30.00	8.67	60.00	4.33	80.00	3.25
	3	60.00	4.33	18.00	14.44	30.00	8.67	37.80	6.88	45.00	5.78	90.00	2.89	120.00	2.17
	4	80.00	3.25	24.00	10.83	40.00	6.50	50.40	5.16	60.00	4.33	120.00	2.17	160.00	1.63
	4.5	90.00	2.89	27.00	9.63	45.00	5.78	56.70	4.59	67.50	3.85	135.00	1.93	180.00	1.44



## SMZ-161 Schematic Diagrams

SMZ-161-BP

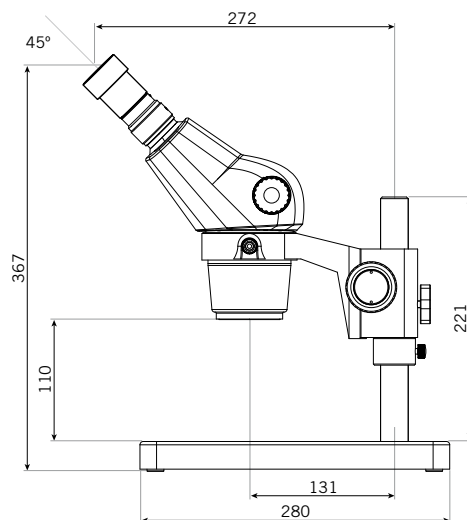
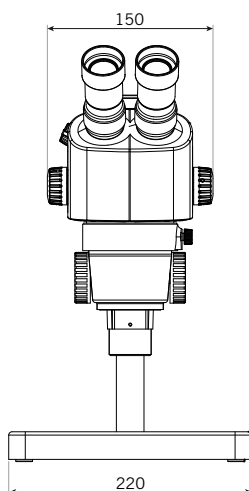

SMZ-161-BP (60°)

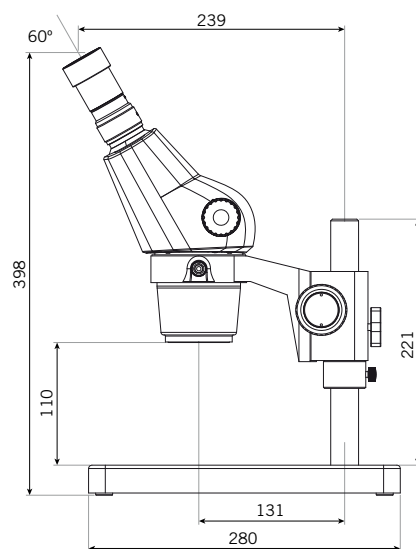
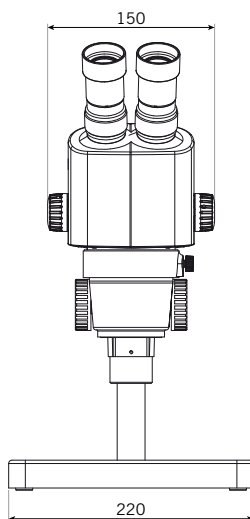

SMZ-161-BL

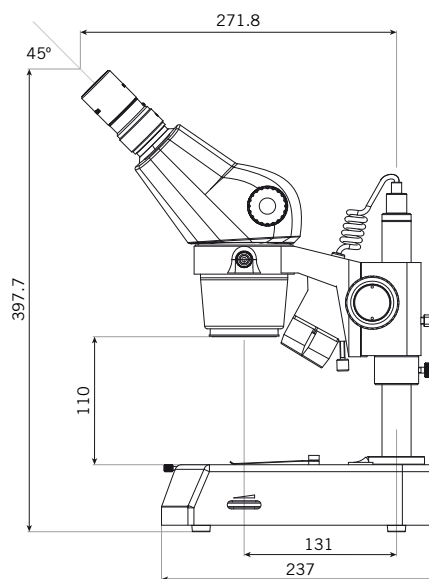
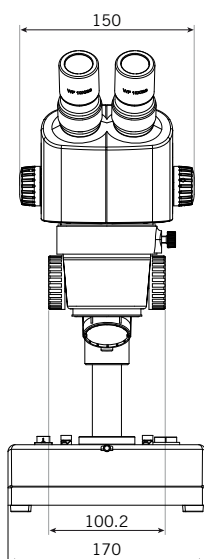

# SMZ-161 System Diagram

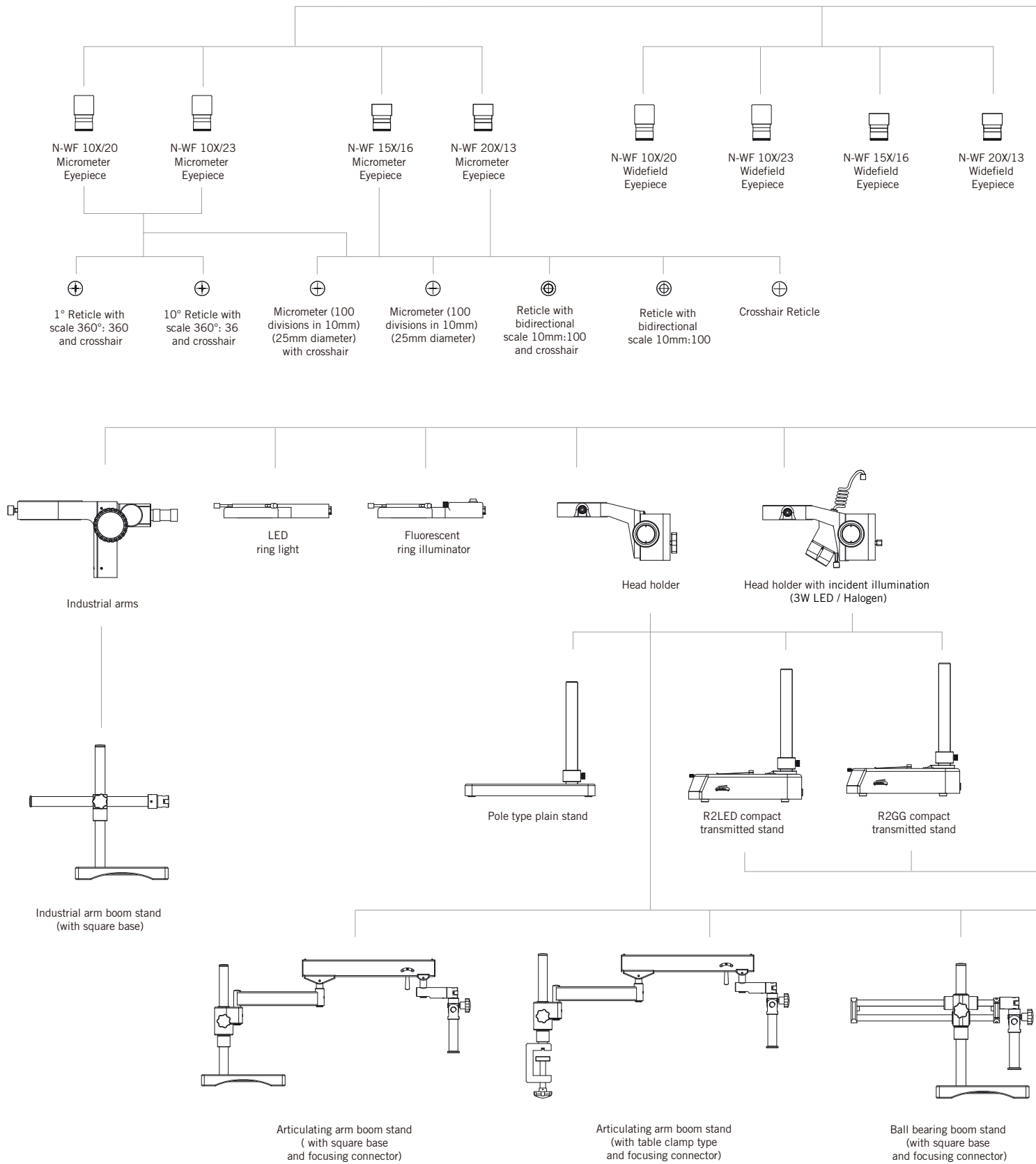

4X Photo Eyepiece      2.5X Photo Eyepiece

1X Adapter

0.65X Adapter

0.5X Adapter

Photo adapter

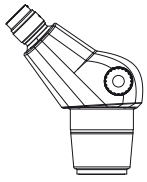

161-BH

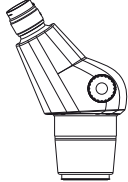

161-BH (60°)

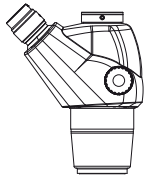

161TH



2X Auxiliary objective



1.5X Auxiliary objective



0.75X Auxiliary objective



0.63X Auxiliary objective



0.5X Auxiliary objective



0.3X Auxiliary objective

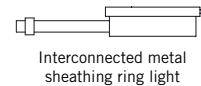

Interconnected metal sheathing ring light

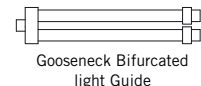

Gooseneck Bifurcated light Guide

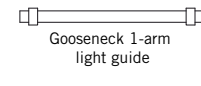

Gooseneck 1-arm light guide



Flexible light guide

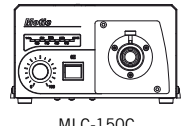

MLC-150C



Blue filter



Jewellery Clip



Polarising equipment (1 piece rotary)



Darkfield attachment

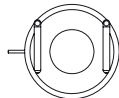

Gliding stage

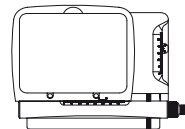

Mechanical stage

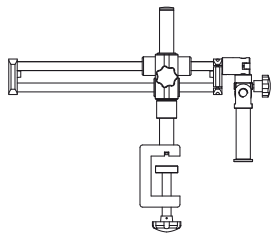

Ball bearing boom stand (with table clamp type and focusing connector)

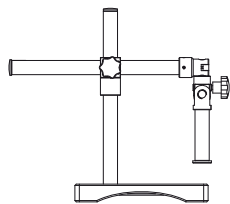

Special universal stand (with square base and focusing connector)

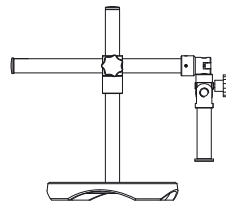

Special universal stand (with round base and focusing connector)

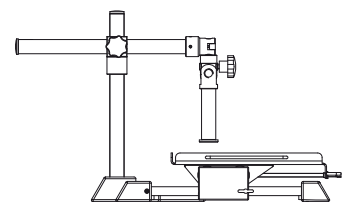

Manual movement stand



# Motic®

[www.moticeurope.com](http://www.moticeurope.com)

**Motic Instruments (CANADA)**

130 - 4611 Viking Way. Richmond, BC V6V 2K9 Canada  
Tel: 1-877-977 4717 Fax: 1-604-303 9043

**Motic Deutschland GmbH (GERMANY)**

Christian-Kremp-Strasse 11, D-35578 Wetzlar, Germany  
Tel: 49-6441-210 010 Fax: 49-6441-210 0122

**Motic Incorporation Ltd. (HONG KONG)**

Rm 2907-8, Windsor House, 311 Gloucester Road,  
Causeway Bay, Hong Kong  
Tel: 852-2837 0888 Fax: 852-2882 2792

**Motic Spain, S.L. (SPAIN)**

Polígono Industrial Les Corts, Camí del Mig, 112  
08349 Cabrera de Mar, Barcelona, Spain  
Tel: 34-93-756 6286 Fax: 34-93-756 6287

\* **CCIS®** is a trademark of Motic Incorporation Ltd.

**Motic Incorporation Limited Copyright © 2002-2013.  
All Rights Reserved.**

**Design Change :**

The manufacturer reserves the right to make changes in instrument design in accordance with scientific and mechanical progress, without notice and without obligation.



January 2013

