



# ECLIPSE *Si*

Upright Microscope



Shedding New Light  
On **MICROSCOPY**

# Focus in comfort. Comfort in focus.

Nikon has designed the ECLIPSE Si to meet the rigorous demands of professionals who spend hours using the microscope. The ECLIPSE Si is ergonomically designed to enhance operational efficiency. This powerful instrument helps you to stay focused for longer by reducing the strain on your body. The ECLIPSE Si is the new standard in microscopes, expanding the possibilities of exploring the micro world.



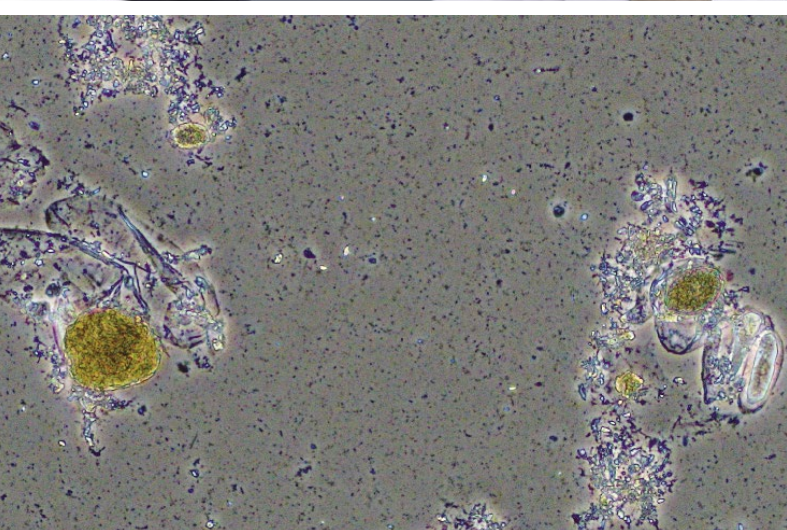
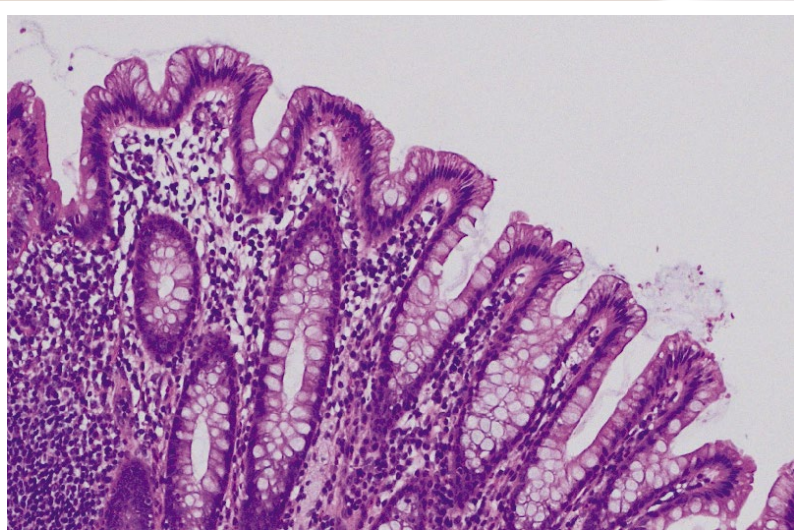

# Pursuing efficient workflow

The ECLIPSE Si has been developed with the primary goal of reducing fatigue during microscope usage. The ECLIPSE Si eliminates unnecessary adjustments and enables efficient and comfortable operation. The ergonomic design also enables natural posture, even when carrying out repetitive tasks.



## Maintains comfortable brightness when switching magnifications

Objective lenses with different magnifications transmit light to varying degrees. Therefore, light intensity must be adjusted every time the user changes the objective. In addition, when switching from high to low magnification objectives, the sudden increase in brightness often causes eye strain. The ECLIPSE Si features the intelligent Light Intensity Management (LIM) which automatically remembers and sets the light intensity level for each objective. The LIM feature reduces up to 40% of the time spent on adjusting light intensities\*. With the ECLIPSE Si, users can increase comfort and save time even when the routine requires frequent magnification changes..

\*Compared to a previous LED model as regards time required to change three objectives and adjust light intensities (test carried out by Nikon)



Push the brightness control knob briefly to activate the LIM feature.

### LIM feature OFF

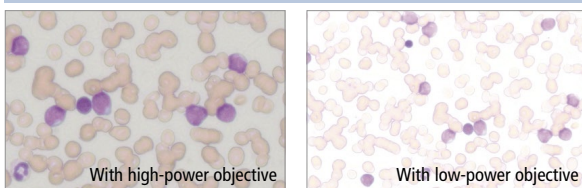

Since brightness varies depending on the objective, switching magnifications can induce eye strain.

### LIM feature ON

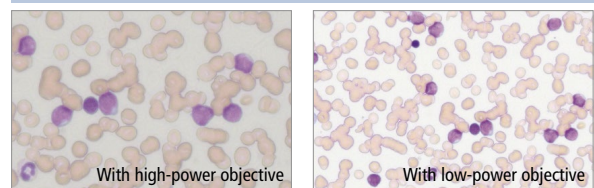

The optimal light intensity level is automatically recalled and applied to each objective, therefore eliminating unexpected changes in light intensity when changing magnifications and streamlining workflow.

## Low stage for effortless slide replacement

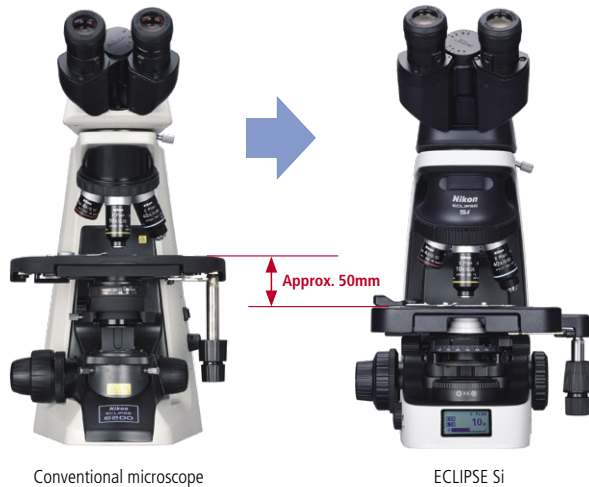

The height of ECLIPSE Si stage is 135 mm, which is about 50 mm lower than our conventional microscopes. The lower stage design reduces the range of motion required to exchange specimen slides, and in turn this can reduce arm and shoulder fatigue. Since the position of the stage movement knob is also lower, different areas on the specimen slide can be easily explored while resting your hands on the table. The lever for opening and closing the specimen holder has also been designed to be ergonomic with an easy-to-operate size and shape. Furthermore, the ECLIPSE Si features a 30% smaller stage compared to our conventional microscopes in order to optimise slide replacement.



Easy-to-operate specimen holder

## Enables natural posture to be maintained throughout the entire microscope workflow

The inclination angle of the eyepiece tube is 45 degrees, which enables observation through the eyepieces while maintaining a natural posture. The low stage design also allows you to seamlessly switch from looking through the eyepieces to checking the slide placement on the stage without having to adjust your posture. An optional eye-level riser is also available to further tailor the height of the eyepieces.

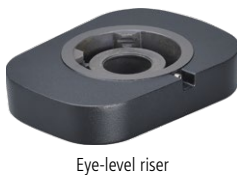

Eye-level riser



Check on the stage while maintaining the observation posture

## Worry free focusing thanks to vertical stop

The ECLIPSE Si is equipped with a stopper that can be used to set the upper limit of the stage height. The stage stops at the set height even when the focus knob is turned, thereby eliminating the risk of over-focusing and breaking the slides or damaging the objectives.

Specimen exchange and focusing can be performed with confidence, without worrying about the stage height.



The stage does not rise above the set height.



Easy operation just by turning the screw at the height you want to set

# Pursuing stress-free ease of use

We wanted to design a microscope that would eliminate fatigue incurred by frequent specimen exchanges and provide a more comfortable user experience. The ECLIPSE Si combines innovative features and intelligent design to minimize unnecessary body movements, saving time and reducing strain on the user even when examining a large number of slides.



## Adjusting focus and moving the stage with one hand

The coarse and fine focus knobs are located on both sides of the microscope, making it possible to focus with either hand. In addition, the stage handle is positioned close to the focus knob, allowing users to easily adjust both the stage position and focus with the same hand. With the stage movement and focus controlled by the same hand, the other hand can be dedicated to rotating the nosepiece or replacing the slides. These features provide an efficient workflow even when examining a large number of specimen slides.



Coarse focus knob

Fine focus knob

Coarse/fine focus and stage movement can be operated with one hand

## Status display

The illumination brightness is shown in a bar graph on the LCD. You can check the magnification at a glance while maintaining your observation posture.



- ① ECO mode: ON
- ② LIM function: ON
- ③ Brightness state
- ④ Objective name
- ⑤ Magnification

## Knob rotation direction

The direction of rotation of the focus and brightness control knobs can be intuitively grasped.



## No hesitation in choosing a knob to operate

The icon of the stage movement knob to be operated is illustrated on the travel scale of the specimen in the forward-backward and right-left directions.



## Changing magnifications comfortably

The reversed-type nosepiece provides easy access and visibility to the objective lens in use. The position of the nosepiece is low to reduce strain on the arm when frequent magnification changes are required. The nosepiece features an easy grip for smooth rotation, and accommodates up to five objective lenses to provide a wide range of magnifications.



Easy-to-rotate quintuple nosepiece



## Blocks blue component in LED light

Since LED light contains a large amount of blue or short wavelength light, there is concern that prolonged observation may put a strain on the eyes. The ECLIPSE Si offers an optional blue light blocking filter that can be placed on the field lens to remove the blue component of the LED light.



## Automatically powers off after a period of inactivity

The ECLIPSE Si is equipped with an ECO mode which automatically turns off the illumination after a certain period of inactivity. The length of the inactivity period is adjustable. With ECO mode, the ECLIPSE Si helps you save power without any effort.



Press and hold the brightness control knob to turn on the ECO mode

# Easily share images on-site and remotely

Capture specimen images for documentation or for real-time sharing with others by configuring the ECLIPSE Si (trinocular version) with a digital camera.

When the ECLIPSE Si is configured with the Digital Sight 1000 microscope camera (optional), images of specimens can be easily displayed on the monitor for simultaneous observation by multiple people, and recorded without the use of a PC. Furthermore, by connecting the camera to a tablet PC\*, images can be shared in real time with remote or off-site PCs and smart devices via a network.

The DS-Fi3\* high-definition microscope camera, which faithfully captures the true colors of specimens, is also available.

\* NIS-Elements L imaging software is required.



Digital Sight 1000 microscope camera



Simultaneous observation and display of specimens on a monitor



Share images in real-time with PCs in another room or building

# Superior Optics for High Quality Images

Nikon's advanced optical technologies, culminating from a long tradition as a microscope manufacturer, play a vital role in the ECLIPSE Si. The ability to fulfill the need for accurate observation of specimens is a source of pride for us.



## Excellent image flatness and chromatic aberration correction

The ECLIPSE Si employs CFI E Plan series objectives, which feature flat, sharp images up to the periphery of the field of view. These objectives are part of the CFI60 infinity-corrected optical system, which achieves both high resolution and long working distances. A wide variety of Nikon CFI60 objectives are available.



CFI E Plan series objectives

## Long-life LED with constant color temperature

The high-intensity, white LED light source, features a long life of up to 60,000 hours. Since the color temperature remains constant even when the brightness is changed, the color of the image does not change when changing magnifications.

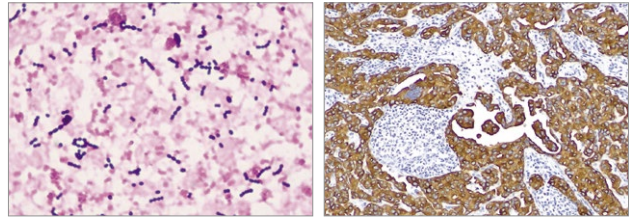

## Observation with FOV of 22mm

The ECLIPSE Si can enhance the efficiency of clinical observations when equipped with FOV22 tubes\* and lenses that enable a large 22mm field of view.

\*C-TB, C-TF, C-TT and C-TE2 tubes

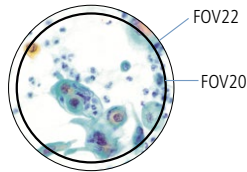

## Uniform brightness up to the periphery of the field of view

The illumination system features an integrated fly-eye lens which provides uniform brightness over the entire field of view.

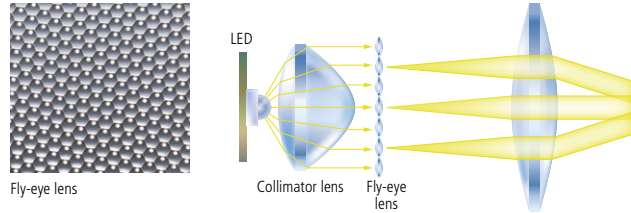

Fly-eye lens

Collimator lens

Fly-eye lens

## Blocking light from outside the field of view

The ECLIPSE Si is equipped with a field diaphragm that can be used to limit the illumination range for optimal observation and image acquisition. Adjusting the field diaphragm suppresses the occurrence of flare and ghosting, enabling high contrast image observation. During fluorescence observation, the range of photobleaching of specimens can also be limited.



Turn the field diaphragm dial until the illumination range is circumscribed to the field of view.



# Compatible with a Wide Variety of Observation Methods

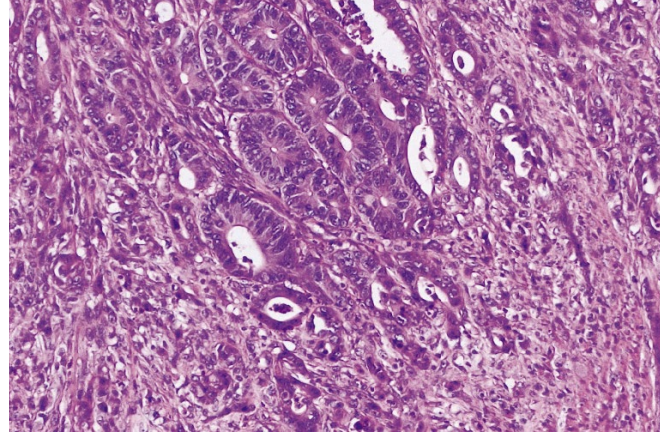

Using optional accessories, the ECLIPSE Si allows for a wide variety of observation methods in addition to bright-field.

## Bright-field observation

High-quality images can be acquired with bright, uniform illumination over the entire field of view, using objectives with superior image flatness and excellent chromatic aberration correction.

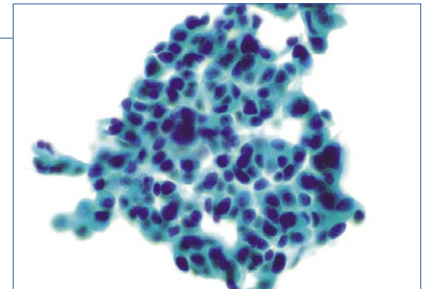

## Phase contrast observation

By inserting a phase contrast slider into the condenser slot and attaching a GIF filter to the field lens, colorless and transparent specimens can be observed with high contrast without staining or labeling with dyes. 10X/20X/40X/100X phase contrast objectives are available.



Phase contrast sliders  
GIF filter  
Centering telescope



Phase contrast objectives

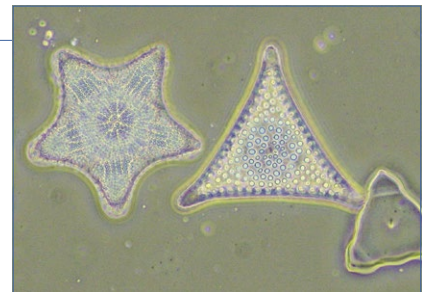

## Dark-field observation

By inserting a slider for dark-field microscopy into the condenser slot and using oblique illumination, light scattered by specimens can be visualized. This method is effective for observation of unstained specimens such as live bacteria and examination of colloidal particles.



Dark-field slider

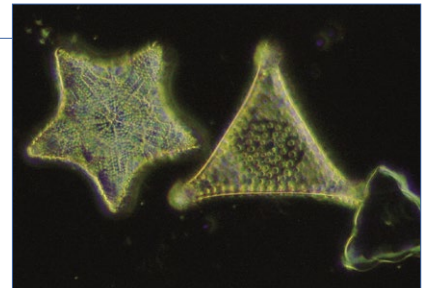

## Simple polarizing observation

By attaching a polarizer to the field lens and an analyzer to the eyepiece tube mount, simple polarizing observation can be performed. The polarization state can be adjusted by turning the polarizer.



Polarizer and analyzer for simple polarizing

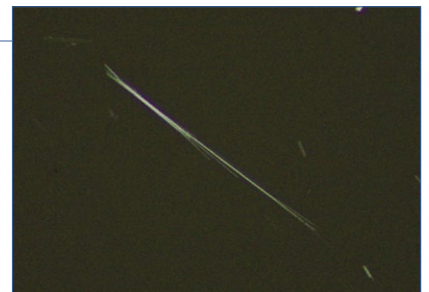

## Diascopic fluorescence observation

Nikon has developed a unique diascopic fluorescence illumination method that enables easy fluorescence observation without attaching dedicated episcopic illuminator and fluorescence observation equipment. By simply inserting an EX filter slider into the condenser slot and a BA filter slider into the nosepiece slot, fluorescence observation of specimens expressing GFP or stained with fluorescent dyes such as FITC and Alexa 488 can be performed.

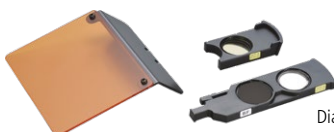

Diascopic fluorescence set

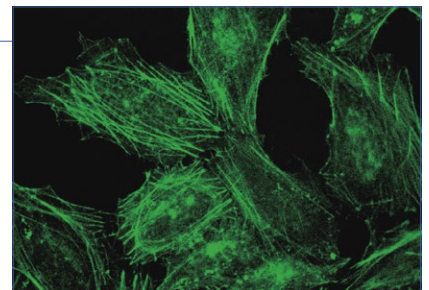

# Online Guide accessible with a Smartphone

You can access a web-based operation manual for the ECLIPSE Si on your smartphone by simply scanning the QR code sticker attached to the microscope. The Online Guide provides visual instructions including movies that enable you to quickly check how to setup and use the microscope.

\*QR code is a registered trademark of DENSO WAVE INCORPORATED.



## Optional accessories

### Digital Sight 1000 microscope camera

Equipped with a 2-megapixel CMOS image sensor, the Digital Sight 1000 can acquire color images and movies of up to 1920 x 1080 pixels. Just connect a monitor\* and a mouse, and you can easily capture images without using a PC.

\*Via a HDMI cable.

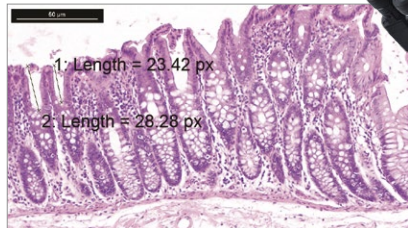

Simple measurements including distances between two points and areas are possible.



### DS-Fi3 microscope camera

Equipped with a 5.9-megapixel CMOS image sensor. The DS-Fi3 can acquire high-resolution color images of up to 2880 x 2048 pixels\*. Its excellent color reproducibility enables the acquisition of images with colors faithful to those of the images observed under the microscope. Its high sensitivity also makes the DS-Fi3 ideal for acquiring fluorescence images.

\*NIS-Elements L imaging software is required for controlling the camera.



### NIS-Elements L imaging software

By connecting the Digital Sight 1000 or DS-Fi3 to a tablet PC with NIS-Elements L installed, images of specimens under observation can be shared with other PCs via a network. The software also contains a variety of measurement and annotation functions.



### Teaching Head

Enables simultaneous observation by two people using the same microscope. Available in two types: face-to-face type and side-by-side. Areas of interest can be indicated with the built-in LED pointer.



### Eye-level Riser

By mounting the eye-level riser under the eyepiece tube, the eyepoint can be raised by 25 mm. The height of the eyepiece can be adjusted to fit the observer, which allows observation in a comfortable posture.

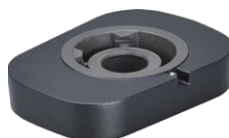

Up to two pieces (50 mm) can be mounted.

# System diagram

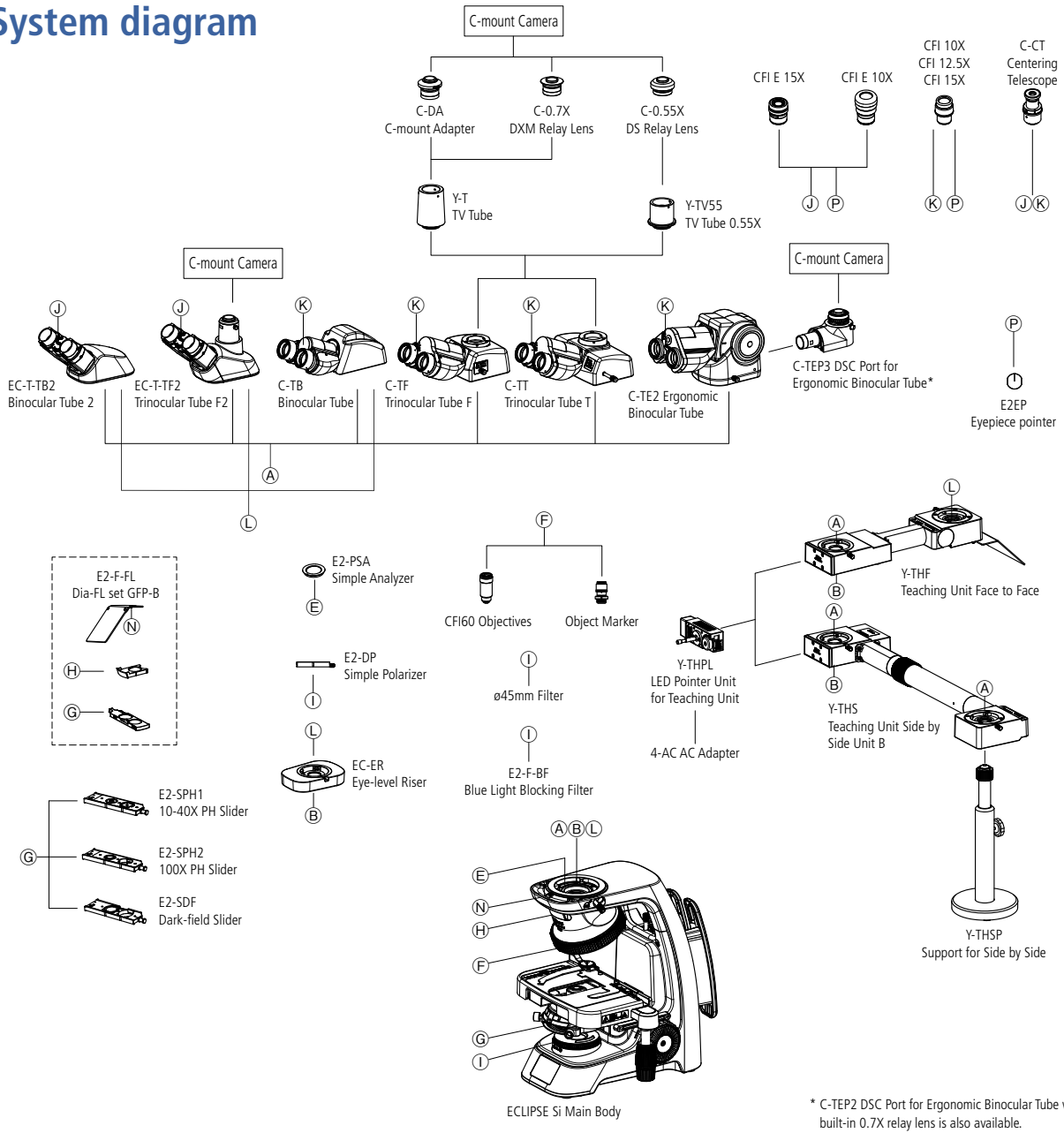

# Dimensional diagram

Configured with binocular tube

Unit: mm

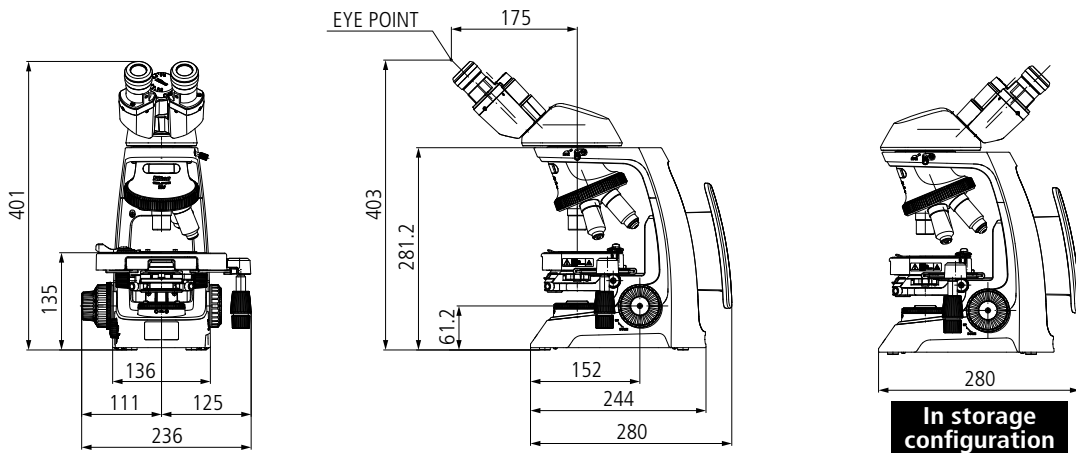

# Specifications

Model name	Main body: ECLIPSE Si
Optical system	CFI60 infinity optical system
Illumination	High luminescent white LED illuminator (Eco-illumination) <ul style="list-style-type: none"> <li>• Built-in fly-eye lens</li> <li>• Up to two 45 mm diameter filters can be installed*1</li> <li>• Light Intensity Management (LIM) feature included</li> </ul>
Focusing	Coaxial coarse/fine focusing (located on both sides), cross roller guide, Focusing stroke: Up 2 mm/Down 13 mm, coarse: 37.7 mm per rotation, fine: 0.2 mm per rotation, minimum reading: 2 μm With coarse focus knob torque adjustment ring and stage vertical movement stopper
Eyepieces (F.O.V., mm)	With diopter adjustment <ul style="list-style-type: none"> <li>• E2-CFI 10X (20)*2, E2-CFI 15X (12)*2</li> <li>• CFI 10X (22)*3, CFI 12.5X (16)*3, CFI 15X (14.5)*3</li> </ul>
Tubes	Inclination angle 45°, pupillary distance: 50-75 mm, eyepoint height: adjustable to 2 positions <ul style="list-style-type: none"> <li>• EC-T-TB2 Binocular Tube 2</li> <li>• EC-T-TF2 Trinocular Tube F2</li> </ul> (Eyepiece: Port: 50:50, built-in 0.55X relay lens in camera port, with C-mount) Inclination angle 25°, pupillary distance: 50-75 mm <ul style="list-style-type: none"> <li>• C-TB Binocular Tube</li> <li>• C-TF Trinocular Tube F (Eyepiece: Port = 100:0, 0:100)</li> <li>• C-TT Trinocular Tube T (Eyepiece: Port = 100:0, 20:80, 0:100)</li> </ul> Inclination angle 10°-30°, extension: up to 40 mm <ul style="list-style-type: none"> <li>• C-TE2 Ergonomic Binocular Tube (Eyepiece: Port = 100:0, 50:50 via optional C-TEP3 DSC Port C-0.55X)</li> </ul>
Nosepiece	Reversed-type quintuple nosepiece (within main body)
Stage	Rectangular mechanical stage (within main body), with specimen holder 2L and vernier calibrations, cross travel: 76 (X) x 52 (Y) mm
Objectives (NA/W.D.)	<ul style="list-style-type: none"> <li>• CFI E Plan Achromat 4X (0.1/30mm)</li> <li>• CFI E Plan Achromat 10X (0.25/7mm)</li> <li>• CFI E Plan Achromat 40X (0.65/0.65mm)</li> <li>• CFI E Plan Achromat 60X (0.8/0.3mm)</li> <li>• CFI E Plan Achromat 100X Oil (1.25/0.23mm)</li> </ul> Other CFI60 objectives can also be used. Objectives for phase contrast observation: <ul style="list-style-type: none"> <li>• CFI Achromat DL 10X (0.25/7.0mm)</li> <li>• CFI Achromat LWD DL 20X (0.40/3.90mm)</li> <li>• CFI Achromat DL 40X (0.65/0.65mm)</li> <li>• CFI Achromat DL 100X Oil (1.25/0.23mm)</li> </ul>
Condenser	Abbe Condenser, NA 1.25, vertically movable and centerable
Observation methods*4	Brightfield, phase contrast, diascopic fluorescence, dark-field, simple polarizing
Fungus-proof treatment	Antifungal paint is applied around optical system
Optional accessories	<ul style="list-style-type: none"> <li>• E2-SPH1 10X-40X PH slider/E2-SPH2 100X PH slider (used with phase contrast objectives)</li> <li>• E2-F-FL Dia-FL set GFP-B</li> <li>• E2-SDF dark-field slider</li> <li>• E2-DP simple polarizer, E2-PSA simple analyzer</li> <li>• EC-ER eye-level riser</li> <li>• E2-F-BF blue light blocking filter</li> <li>• Object marker</li> <li>• Eyepiece pointer</li> <li>• Teaching head</li> </ul>
Power supply	Uses the included AC adapter (input: 100-240 VAC, 0.48A Max., 50-60 Hz, output: 5.0 VDC, 3.0A Max.)
Power consumption (max.)	Nominal value: 5 W
Weight	Approx. 6.0kg (when equipped with binocular tube), approx. 6.4kg (when equipped with trinocular tube)

\*1 When a simple polarizer is attached, only one filter can be installed

\*2 Used in combination with EC-T-TB2 Binocular Tube 2 or EC-T-TF2 Trinocular Tube F2

\*3 Used in combination with C-TB Binocular Tube, C-TF/C-TT Trinocular Tubes or C-TE2 Ergonomic Binocular Tube

\*4 Observations other than brightfield require optional accessories.

Cooperation between pathological specimens and imaging guidance  
Dr. Yasushi Nakamura, Pathologist, Osaka Cytopathological Laboratory

Digital Sight 1000 and DS-Fi3 microscope cameras, and NIS-Elements L imaging software are not for clinical use. Specifications and equipment are subject to change without any notice or obligation on the part of the manufacturer.  
April 2021 ©2021 NIKON CORPORATION

 <b>WARNING</b>	<b>TO ENSURE CORRECT USAGE, READ THE CORRESPONDING MANUALS CAREFULLY BEFORE USING YOUR EQUIPMENT.</b>
--	---

Monitor images are simulated.  
Company names and product names appearing in this brochure are their registered trademarks or trademarks.  
N.B. Export of the products\* in this brochure is controlled under the Japanese Foreign Exchange and Foreign Trade Law.  
Appropriate export procedure shall be required in case of export from Japan.  
\*Products: Hardware and its technical information (including software)



ECLIPSE Si product page



Nikon Healthcare Business Unit website



## NIKON CORPORATION

Shinagawa Intercity Tower C, 2-15-3, Konan, Minato-ku, Tokyo 108-6290, Japan  
phone: +81-3-6433-3705 fax: +81-3-6433-3785  
<https://www.healthcare.nikon.com/en/>

ISO 14001 Certified  
for NIKON CORPORATION

### Nikon Instruments Inc.

1300 Walt Whitman Road, Melville, N.Y. 11747-3064, U.S.A.  
phone: +1-631-547-8500; +1-800-52-NIKON (within the U.S.A. only)  
fax: +1-631-547-0299  
<https://www.microscope.healthcare.nikon.com/>

### Nikon Europe B.V. (headoffice)

Tripolis 100, Burgerweeshuispad 101, 1076 ER Amsterdam, Netherlands  
phone: +31-20-7099-000 fax: +31-20-7099-298  
[https://www.microscope.healthcare.nikon.com/en\\_EU/](https://www.microscope.healthcare.nikon.com/en_EU/)

### Nikon Instruments (Shanghai) Co., Ltd.

CHINA phone: +86-21-6841-2050 fax: +86-21-6841-2060  
(Beijing branch) phone: +86-10-5831-2028 fax: +86-10-5831-2026  
(Guangzhou branch) phone: +86-2-3882-0551 fax: +86-2-3882-0580  
[https://www.microscope.healthcare.nikon.com/zh\\_CN/](https://www.microscope.healthcare.nikon.com/zh_CN/)

### Nikon Canada Inc.

CANADA phone: +1-905-625-9910 fax: +1-905-602-9953

### Nikon France, Succursale de Nikon Europe B.V.

FRANCE phone: +33-1-4516-4516 fax: +33-1-4516-4505

### Nikon Deutschland, Zweigniederlassung der Nikon Europe B.V.

GERMANY phone: +49-211-9414-888 fax: +49-211-9414-322

### Nikon Italy, Branch of Nikon Europe B.V.

ITALY phone: +39-055-300-9601 fax: +39-055-300-993

### Nikon Europe B.V., Amsterdam, Zweigniederlassung Schweiz (Egg/ZH)

SWITZERLAND phone: +41-43-277-2867 fax: +41-43-277-2861

### Nikon UK, Branch of Nikon Europe B.V.

UNITED KINGDOM phone: +44-208-247-1717 fax: +44-208-541-4584

### Nikon Österreich, Zweigniederlassung der Nikon Europe B.V.

AUSTRIA phone: +43-1-972-6111 fax: +43-1-972-6111-40

### Nikon Singapore Pte Ltd

SINGAPORE phone: +65-6559-3651 fax: +65-6559-3668

### Nikon Instruments Korea Co., Ltd.

KOREA phone: +82-2-6288-1900 fax: +82-2-555-4415